



TOX[®] Powerpackage

Pneumohydraulic drives with press forces of 2 – 2000 kN



For forces of 2 – 2000 kN

If high forces need to be generated efficiently in a small space, pneumo-hydraulics come into play. TOX® PRESSOTECHNIK knows how to effectively combine the benefits of compressed air and oil. The result is the TOX® Powerpackage – powerful pneumohydraulic drive cylinders, providing a press force of up to 2000 kN.

Inside the TOX® Powerpackage is a double guided working piston, working hand in hand with an intensifier piston. While the pneumatic control ensures high speeds, the pneumohydraulic process step is responsible for accurate application of force. Compressed air and oil are reliably separated here, preventing any risk of contamination. The TOX® Powerpackage is controlled like a normal, double acting pneumatic cylinder.

The functional design, with few movable parts, reduces wear and increases the service life. The low impact forces of the fast stroke protect the tool and reduce the noise level. A mechanical spring with dual function ensures low energy consumption: No air is required for the return stroke of the intensifier piston, and the constant pressure on the oil reservoir enables assembly of the cylinder in any alignment. The low energy usage in the unit allows for a significant increase of the speed when using the smallest valve cross-sections. This saves cost and space for the installation.

Unrivalled quality

The pneumohydraulic TOX® Powerpackage impresses compared to mechanical drives, toggle systems, hydraulic drive systems or large-volume pneumatic cylinders with its high power density, flexibility and simplicity.

It was developed for combined force-displacement motion sequences, which require forces of up to 2000 kN and standard powerstrokes up to approx. 80 mm. The standard total stroke is a maximum of 400 mm.

Advantages

- High stroke frequency
- Long service life
- Low energy consumption
- Low noise level
- Minimal maintenance costs

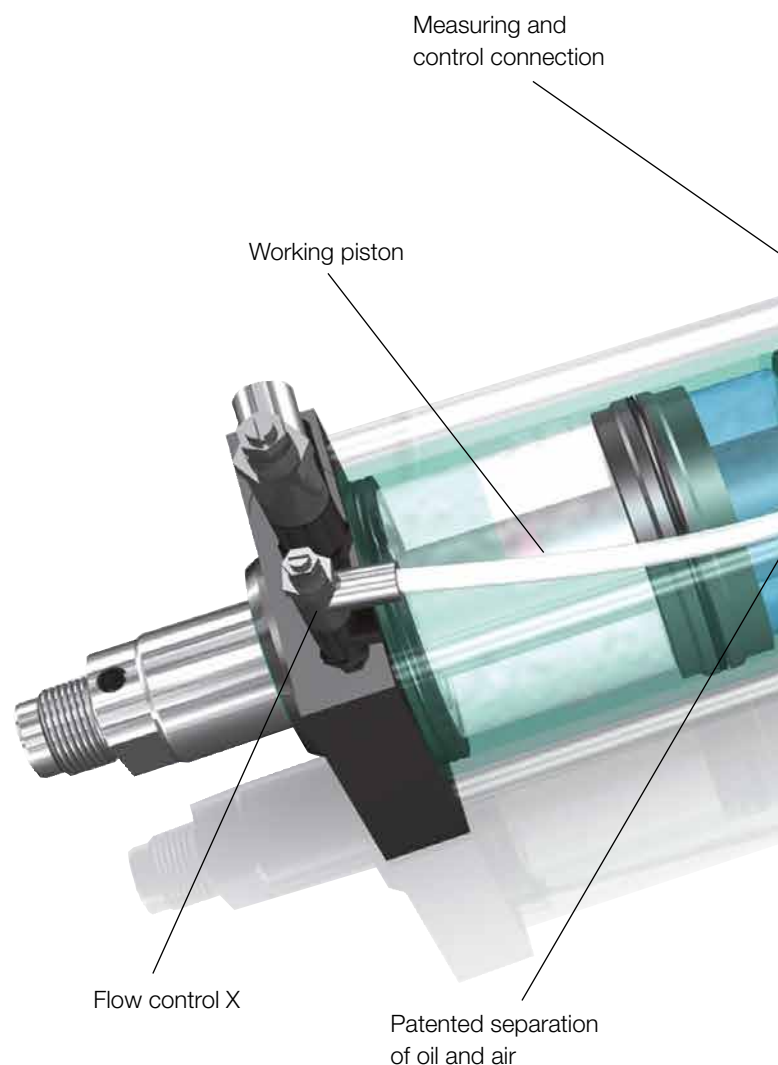

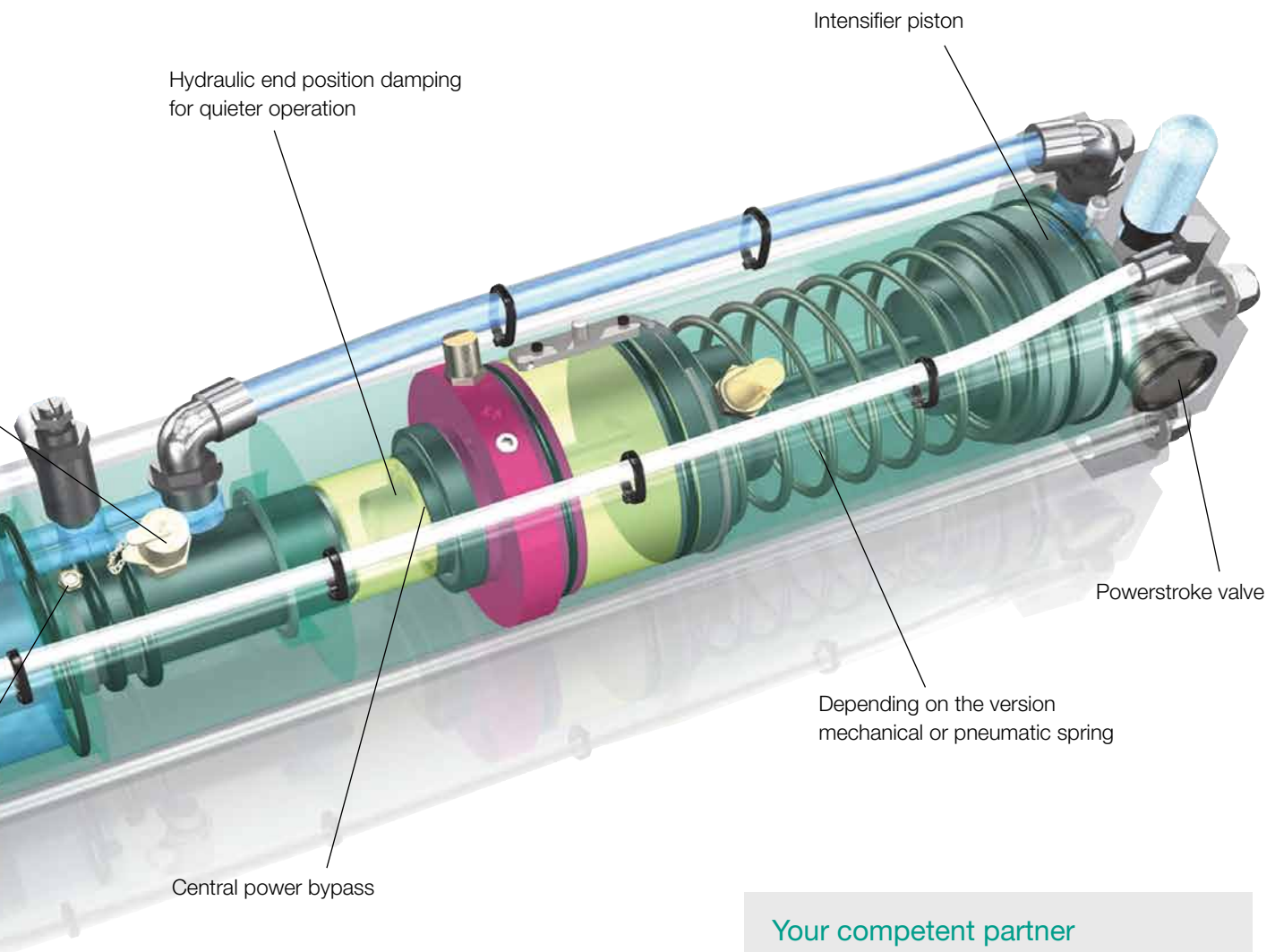

Your competent partner

- Close partnership from planning to operation of the system
- Strong support for commissioning and process optimization
- Worldwide customer service
- Personal 24/7 Hotline exclusively for our customers
- Training at TOX® PRESSOTECHNIK or at your premises
- Factory calibration and repair service
- Efficient remote maintenance

Design

Highly detailed design

The TOX® Powerpackage is a pneumatic cylinder with integrated hydraulic system. It uses the practical benefits of both media and supplements them with numerous technical innovations.

- 1 The TOX® Powerpackage is attached by means of the **flange** with tight tolerance pilot and simple mounting option.
- 2 The end positions of the moveable pistons are equipped with durable **damping elements** – the key to smooth running at the highest stroke frequency.
- 3 All **sealing components** have been optimized in comprehensive long-term tests.
- 4 Special **seals** enable operation with oil-free air.
- 5 The **double guided working piston** directly transmits the force to the workpiece or tool.
- 6 Absolute **separation of air and oil** through two seals with an annular groove in-between. This reliably prevents contamination of the hydraulic oil with air.
- 7 The **high pressure and control connection** enables subsequent functions like press force control, and process pressure monitoring.
- 8 **Oil level indicator**
- 9 **Permanent pressure oil reservoir** for infrequent refilling intervals.
- 10 The patented **anti-overfill safety device** prevents the oil reservoir from overflowing. If too much oil is filled in, it can drain off through its check valve.

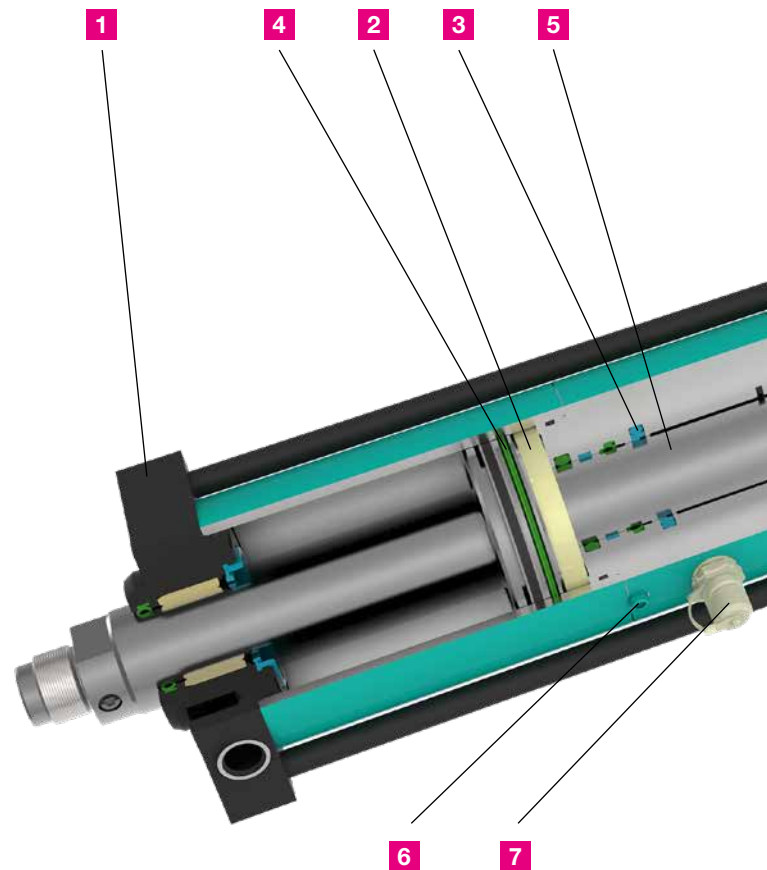

- 11 The **spring** (depending on the version: mechanical or pneumatic spring) meets two functions: reset of the intensifier piston and generation of pressure on the reservoir. This means the oil in the reservoir is under constant pressure. This way, operation is possible in any installation position, for example on a robot.
- 12 The **intensifier piston** generates the force during the powerstroke. It is single-acting and is equipped with a spring reset, thus saving 85 percent of the energy of a double-acting cylinder in the powerstroke.

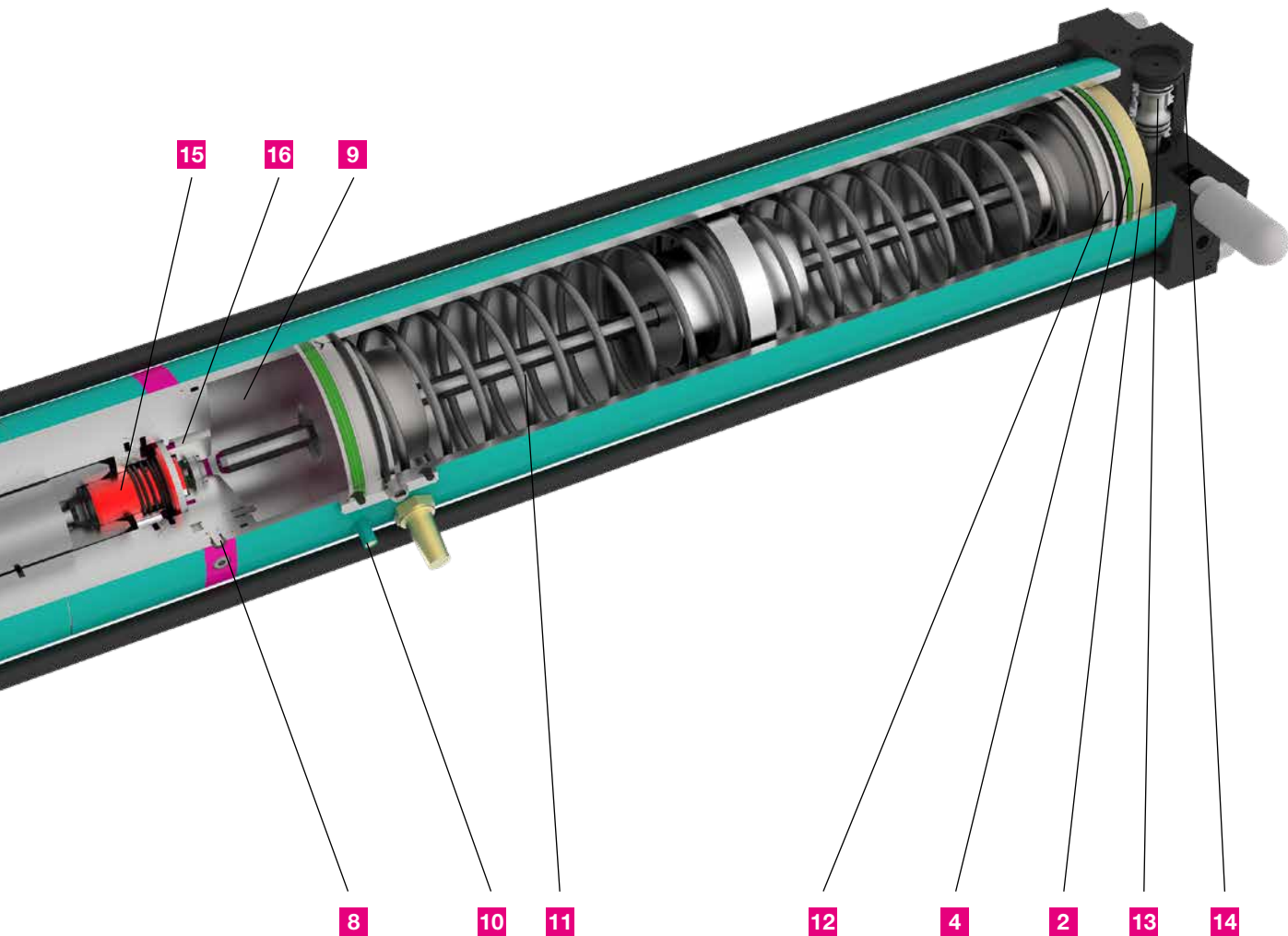

13 The automatic switch from fast approach to power-stroke occurs when the working piston meets resistance at any point of the stroke. The **powerstroke valve** is controlled by to the return stroke chamber and functions according to the dynamic pressure procedure. The changeover time is controlled with the flow control X.

14 The complete **control** is either mounted to or has been integrated into the flange. This ensures a compact design. The TOX® Powerpackage is controlled like any double-acting pneumatic cylinder with a 4/2- or a 5/2-way directional valve.

15 The TOX® Powerpackages line-Q and line-X as well as the special types S (from size S 4) are equipped with a patented, integrated, hydraulic **end position damping**. This guarantees optimum damping in the return stroke – especially in case of applications with high tool weight and high retract speeds.

16 The patented central **power bypass** (ZLB) prevents vacuum formation in the oil system, which can occur during punching or during high stroke speeds.

The patented functional principle

Original position

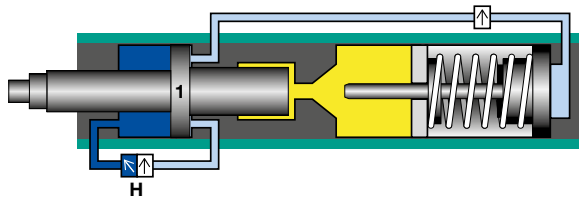

In the **home position**, the drive is held by the main control valve (**H**) in the return stroke. The working piston (**1**) is retracted.

Fast approach

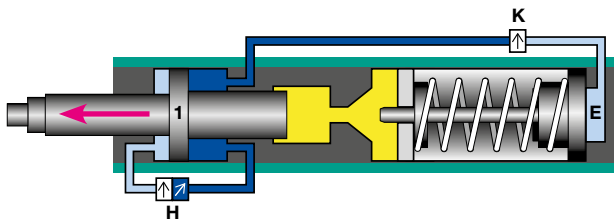

Air-operated **fast approach**: The main control valve (**H**) is actuated. The working piston (**1**) extends in fast approach, until it meets resistance at any point. It stops and the powerstroke valve (**K**) switches. Air now streams into the intensifier chamber (**E**).

Powerstroke

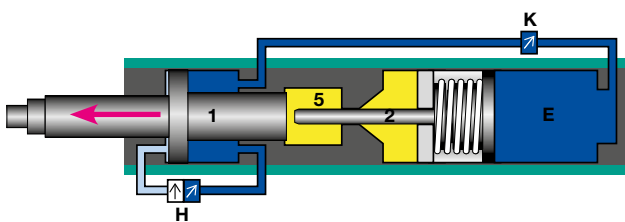

Pneumohydraulic **powerstroke**: The intensifier piston (**2**) closes the high pressure chamber (**5**) and builds the oil pressure in the working area to up to 400 bar. This oil pressure acts on the rear of the working piston (**1**) and generates the powerstroke.

Return stroke

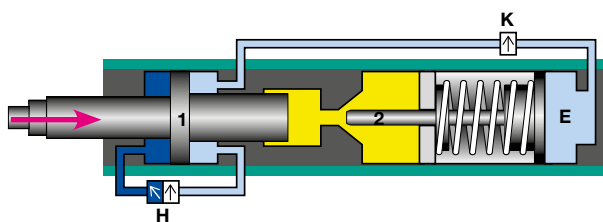

Air-operated **return stroke**: After switching the main control valve (**H**), the powerstroke valve (**K**) vents the chamber (**E**) automatically. The intensifier piston (**2**) is pressed back by spring force and the working piston (**1**) returns to the original position pneumatically.

Power for daily use

The TOX® Powerpackage is a complete drive system. With its various designs and comprehensive accessories it is universally applicable. It can be installed in any position and usually does not require external tool guidance.

TOX®
 quality promise:
 10 million
 strokes in
 12 months!



Ideal for use in various applications



Clinching,
 TOX® Sheet
 Metal Joining



Assembling,
 press-fitting



Pressing-in,
 Insertion of
 functional
 elements



Riveting



Punching,
 piercing



Coining,
 marking



Tensioning,
 clamping



Pressing,
 compressing

The pneumohydraulic drive family

The line-Q series

- Available in common standard sizes
- Shortest delivery times
- Attractive price
- Mechanical return spring

Press forces: 2 – 300 kN
Total stroke: up to 200 mm
Powerstroke: up to 52 mm
Compressed air: 2 – 6 bar

Design S (standard)

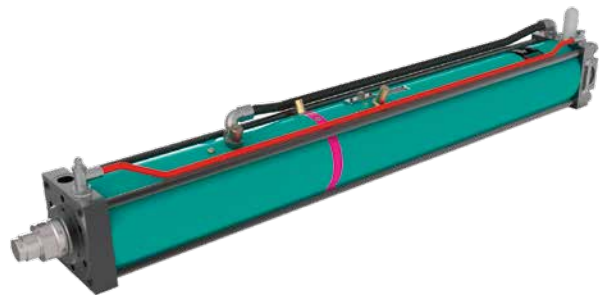

Type Q-S

The line-X series

- Most configurable
- Can be configured according to the applications
- Precisely controllable and adjustable
- High stroke speeds
- Pneumatic spring

Press forces: 2 – 1700 kN
Total stroke: up to 400 mm
Powerstroke: up to 69 mm
Compressed air: 2 – 6 bar

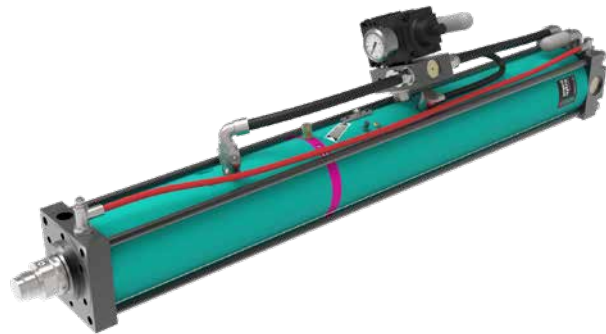

Type X-S

Special types

- Application-specific design
- Complete range of types
- Compatible with the whole range of accessories
- Mechanical spring or air spring (depending on the version)

Press forces: 2 – 1740 kN
Total stroke: up to 400 mm
Powerstroke: up to 80 mm
Compressed air: 2 – 10 bar

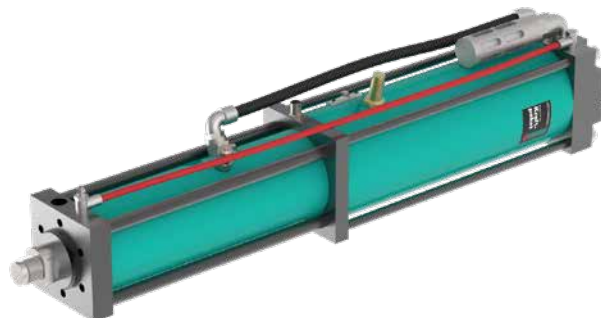

Type S

Design K (compact)



Type Q-K

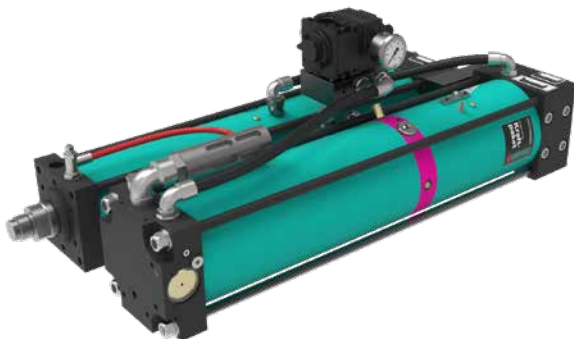

Type X-K

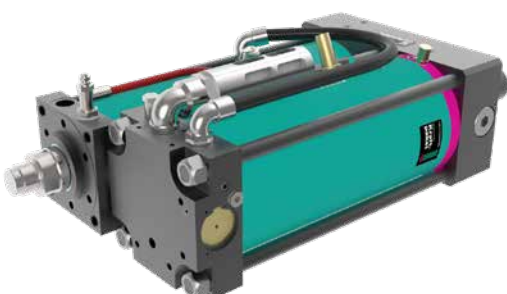

Type K

The series RP (marking cylinder), T (turbo cylinder) and RZ (robot tongs cylinder)

Press forces: 2 – 160 kN
 Total stroke: up to 200 mm
 Powerstroke: up to 12 mm
 Compressed air: 2 – 10 bar



Type RZK

X-KT system

- With separate intensifier for one or several working cylinders
- For long powerstrokes
- Working cylinders can be activated individually
- Compact design, flexible mounting

Press forces: 2 – 2000 kN
 Total stroke: up to 400 mm
 Powerstroke: up to 100 mm
 Compressed air: 2 – 10 bar

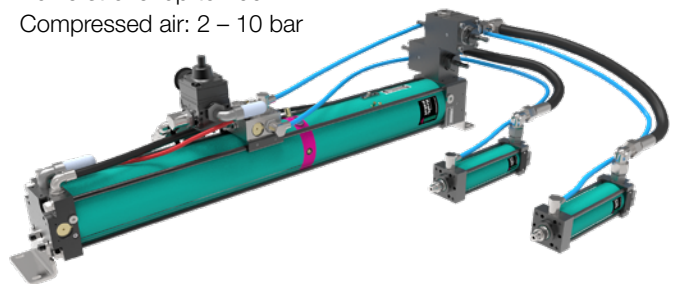

X-KT system

TOX[®] Powerpackage line-Q

The standardized basic system

The line-Q drives are designed for a large number of standard applications and are available in two designs: a straight, slim type Q-S and a compact type Q-K. This preferred series is available in most standard sizes. This means it can be delivered quickly at an attractive price.

The line-Q series is equipped with a sturdy mechanical return spring for constant pressure on the storage piston and is equipped with hydraulic end position damping and power bypass ZLB as standard. This prevents vacuum formation in the oil system, i.e. during fast stroke speeds. Furthermore, this series has a magnetic piston for external sensing.

Advantages

- Short delivery times due to standardized sizes
- Good value for money
- Low air consumption
- Medium maintenance interval

Technical details:

- Central power bypass ZLB
- Hydraulic end position damping ZHD
- Fixed stop with elastomer damping in the forward stroke FUD
- Prepared for stroke request ZHU and external linear position sensor ZHW
- Mechanical return spring

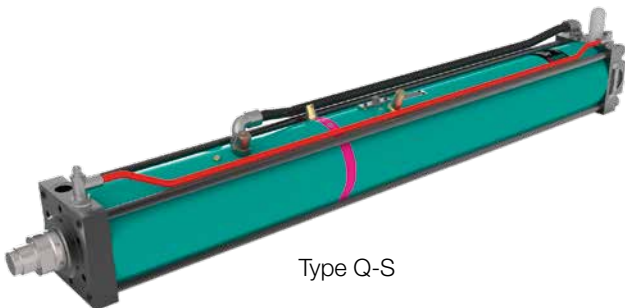

Type Q-S

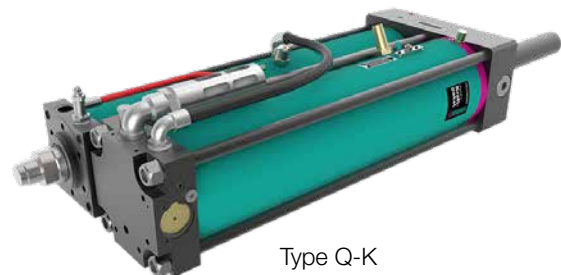

Type Q-K

TOX® Powerpackage line-X

The individual high-end system

The drives of the line-X series enable high fast approach stroke forces and fast stroke speed. They have very low maintenance and repair costs. Furthermore, we can individually adapt them to your application. The line-X drives have a central power bypass as standard, as well as a pneumatic spring instead of the mechanical spring for the intensifier return.

The line-X series is available as type X-S (slim design) and type X-K (compact design). Pneumatic spring, powerstroke valve and fast stroke support are already integrated. Additional components include a pneumatic spring pressure regulator with maximum air flow for maximum cycle times, and an OR valve for fast stroke support.

All line-X drive cylinders are equipped with dynamic pressure control (flow control X). Optional control versions including a pressure regulator in the powerstroke line, external powerstroke connection or external powerstroke release are available. Three pneumatic connections are required: one each for forward and return strokes and one for the pneumatic spring.

Advantages

- Maximum capacity and variability
- Individually adaptable
- Maximum speed
- Long maintenance intervals

Technical details:

- Pneumatic spring
- Central power bypass ZLB
- Hydraulic end position damping ZHD
- Fixed stop with elastomer damping in the forward stroke FUD
- Prepared for stroke request ZHU and external linear position sensor ZHW up to X-S/X-K 030
- Type X-K with patented ring buffer version on the intensifier for significantly shortened installation length
- Option: Distance transducer ZKW on X-K 050 and larger

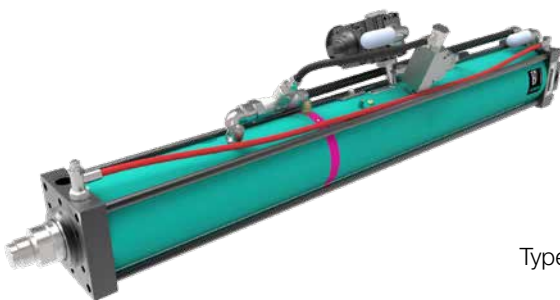

Type X-S

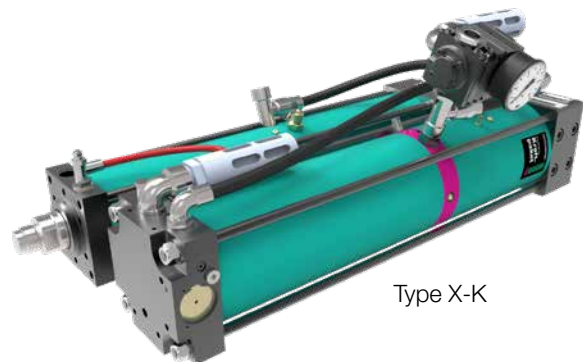

Type X-K

TOX® Powerpackage X-KT system

The separated pneumohydraulic power unit

The TOX® X-KT system consists of the pressure intensifier X-ES and one or several working cylinders. Depending on press force, installation dimensions and cycle time, it is tailored to customer requirements.

Either TOX® Hydraulic Cylinders HZL or pneumatic TOX® Working Cylinders X-AT are used as working cylinders.

Advantages

- Compact installation dimensions
- Long powerstrokes
- Simple control
- Maximum capacity and variability
- Modular concept

Technical details:

- Use of up to 6 working cylinders per pressure intensifier
- Optimum system separation by TOX® Hydro Split Coupling
- Simple color-coded pneumatic plug system
- Optional: selected cylinders can be driven with switchable hydro split coupling

Pressure intensifier X-ES with TOX® Hydraulic Cylinder HZL

- Short design
- Working piston with simple bearing
- Absolute separation of air and oil
- Fixed stop in forward stroke (elastomer damping optional)
- Options: Stroke request ZHU and distance transducer ZKW
- Cost-effective drive solution

Pressure intensifier X-ES with TOX® Working Part X-AT

- High fast and return stroke forces
- Short cycle times
- Fixed stop with elastomer damping in the forward stroke
- Prepared for stroke request type ZHU and external linear position sensor ZHW up to X-AT 030
- All sizes with bypass ZLB incl. hydraulic end position damping ZHD
- Option: Distance transducer ZWK on X-AT 50 and larger



X-KT system integrated in special machine

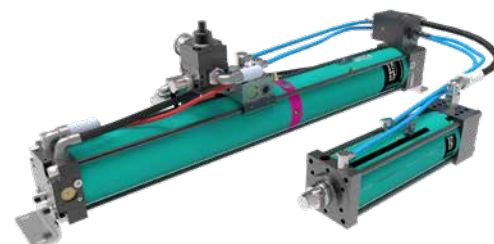
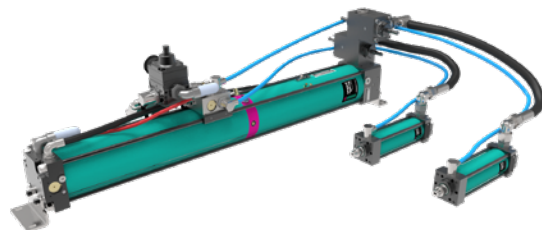

TOX® Powerpackage RZK, RZS, RZH

The specialist for robot tongs

The TOX® Powerpackages RZ are ideal for applications on robot tongs and handheld tongs. These drives can be precisely adjusted with a special flange. This enables highest precision and production quality, even without additional guide for the tool. The robot tong drives are ready for operation in all installation positions.

The TOX® RZ series is available in three different designs: The type RZK is the weight-optimized compact design for robot-controlled and mobile handheld tongs. The particularly slim design of the TOX® Powerpackage RZS is ideal for the press drive, which does not require a guide carriage on the tool. The RZH system is suitable for use on particularly light handheld tongs, or if several hydraulic cylinders are to be used on one intensifier. The hydraulic cylinder RZH(x) in turn is available in two basic versions. Here, the pressure medium used for the return stroke determines the cylinder type: RZHL for pneumatic return stroke and RZHO for hydraulic return stroke.

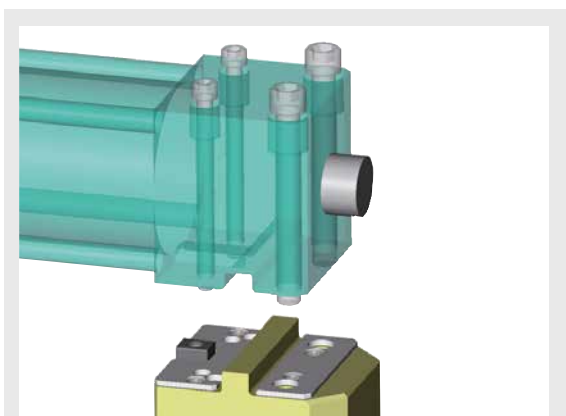

Precise flange connection

The drive can be precisely aligned in both directions perpendicular to the stroke direction by means of custom-fit grooves on the mounting surface of the TOX® Powerpackage type RZ. The height and position of the drive can be adjusted with shims and the key on the mounting surface.

Advantages

- Simple and accurate adjustments of tongs with our special flange
- Short cycle times
- Maximum maintenance intervals

Powerpackage type RZK

- Compact design
- With pneumatic spring
- High stroke rates, short cycle times
- Stroke lengths standardized for TOX® Tongs
- Integrated total stroke adjustment



Powerpackage type RZS

- Long design
- With pneumatic spring
- High stroke rates, short cycle times
- Cost-effective

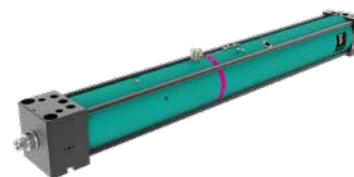

Powerpackage type RZHL / RZHO

- Compact
- Working cylinder RZHL for combination with pressure intensifier X-ES
- Working cylinder RZHO for combination with hydraulic pump
- With special flange for TOX® Tongs
- High stroke rates, short cycle times
- Integrated total stroke adjustment



TOX® Powerpackage special types S, K, T and RP

Whether extremely fast or powerful, with marking tool mounting or defined stroke: In case of unique applications, the special versions of the TOX® Powerpackage S, K, T or RP come into play.

The TOX® Powerpackage S50/80 provides high fast approach and retraction forces and is available with a powerstroke adjustment. The length of the powerstroke can be set independent of the length of the total stroke. This is why this special type is particularly suited to marking of numbers with constant marking depth at different piece part heights.

Alternately, with series K 51/81, the total stroke can be continuously adjusted – independent of the length of the powerstroke and the cylinder length. This is ideal for any forming and joining applications, especially if tools without end stop are used. All designs are also available with flanges and air connections rotated to fit your mounting area.

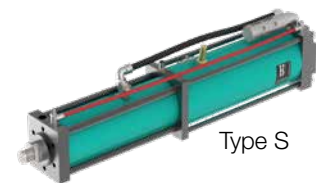

Type S

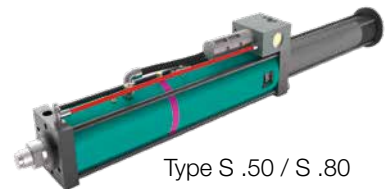

Type S .50 / S .80

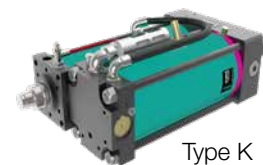

Type K

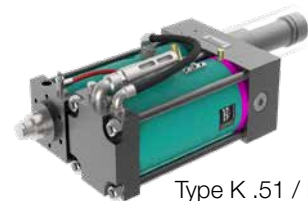

Type K .51 / K .81

Technical details:

- Individual stroke lengths, press forces and dimensions possible
- Optionally with pneumatic or mechanical spring
- Available as 6 bar and 10 bar drives
- All accessories available

The high-speed TOX® Powerpackage T operates with up to 550 strokes per minute. Due to the high speed, the turbo cylinder is particularly suited to punching and nibbling machines.

Type T

- Only powerstroke
- Up to 550 strokes/min
- With pneumatic spring and integrated power bypass
- Constant press force
- Compressed air: up to 10 bar



Designed with a working piston with anti-rotation device, the marking cylinder TOX® Powerpackage RP is ideally suited to stamping and labelling of components.

Type RP

- With anti-rotation device
- With clamping chuck for tool holding fixture
- Setting of stamping depth
- With pneumatic spring
- Compressed air: up to 10 bar

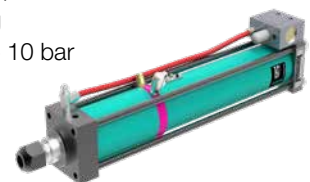

Special versions

Version for usage in the food sector (ZLM)

All TOX® Powerpackages can be filled with food grade oil and grease (both USDA-H11 approved). These units are suited to usage in the food, pharmaceutical and cosmetics industry, where contact with the lubricant cannot be avoided.

Rust-protected versions (ZRO)

If desired, the TOX® Powerpackages are available as rust-protected version. All individual parts are then galvanized, painted or made of stainless steel. These units are particularly suited to usage in the food and packaging industry.

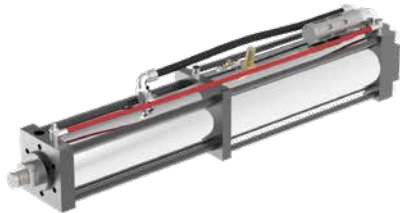

TOX® Powerpackage for the battery production (Cu/Zn/Ni - optimized)

Drives to be used in battery production must meet special requirements. All components such as bearings or guides which can show wear must be designed to prevent short circuits. They should also prevent conductive or interfering particles from getting into the production process. For these drives, some attachment parts and components were designed almost completely without copper, nickel and zinc, some entirely without. The proven pneumohydraulic TOX® Powerpackage is available in this special version in different designs (type S and K; other types on request) and with comprehensive accessories.



Powerstroke servo control ZKPr

Precisely adjustable

The powerstroke servo control ZKPr is a new control with proven mechanics. Based on the precise control in the powerstroke, it optionally provides accurate processes for the TOX® Powerpackages of series line-X or the special types S, K and RZ with integrated pneumatic spring. It can control press forces of up to 150kN and is suited to all applications with a counterforce.

The powerstroke servo control is useful for applications which have a counterforce such as:

- Mounting
- Joining
- Insertion of functional elements
- Pressing
- Marking
- Riveting
- Caulking
- Flaring
- Bending
- Pressing

Functionality of the control

The fast stroke is controlled with a 5/2-way valve. The powerstroke is controlled by means of an intensifier piston and only occurs once the working piston is extended during fast stroke. For controlling the powerstroke, the intensifier piston is controlled with a 5/3-way servo valve, independent of the working piston.

Advantages

- Powerstroke control by means of a servo valve
- Speed, displacement and progression adjustable in the powerstroke
- Stop is optional in absolute or relative position
- Reduced air consumption
- Robust control behaviour by means of hydraulic reduction
- Software protects against overload
- Simple and reliable control
- Can be retrofitted

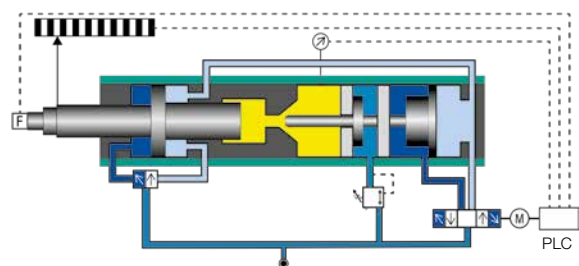

Stroke controls and damping systems

Stroke controls

The stroke of the TOX® Powerpackages can be adapted to individual requirements. The following control units can be used for this:

The **pressure control of the powerstroke line ZDK** enables individual adaptation of the press force by means of a manual pressure valve. The pressure valve can also be installed further away (e.g. in the switch cabinet).

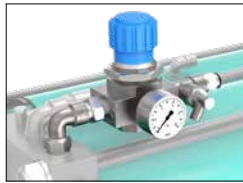

The **external powerstroke activation ZKHZ** realizes the connection of the powerstroke valve by means of an electrically actuated 3/2-way valve. This is recommended for travel-dependent powerstroke connection or for application-related interrupted approach stroke. The ZKHZ is also ideal when using the TOX® Powerpackage with the piston rod pointing upwards and large tool weight.

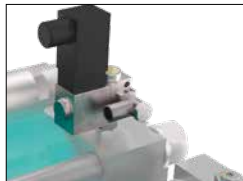

With the **powerstroke deactivation ZKHD**, the powerstroke can be deactivated through an electrical signal (e.g. during setup mode).

The **external powerstroke release ZKHF** secures the activation of the powerstroke valve by means of dynamic pressure control by requesting the release via an additional electrical signal.



The **stroke frequency optimization ZHO** is an optional additional assembly for improving the cycle time (time gained approx. 20 percent) and replaces the existing powerstroke valve with a valve of the next size.



Stroke damping systems

With the **stroke damping ZED**, the speed of the working piston can be controlled across the entire stroke. This is useful for pressing applications to overcome the stick-slip-effect. The damping ensures a gentle approach to the piece part, good pressing results, noise reduction, and avoids high mechanical stresses.

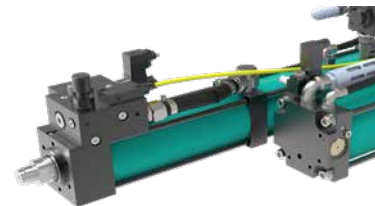

The **cutting impact damping ZSD** dampens the working piston when the counterforce ceases, for example during punching applications. As purely mechanical damping it can also be used as stroke damping with limitations.

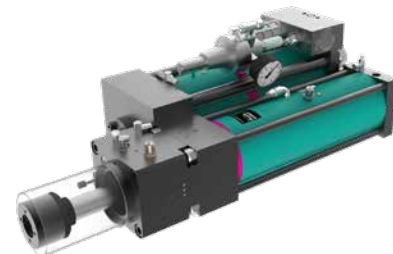

The **holding brake "Safety Lock" ZSL** takes effect in case of pressure loss and prevents the working piston from extending. It works with mechanical clamping jaws and can only be released again through application of pressure. The holding brake is certified by the professional association.



Accessories

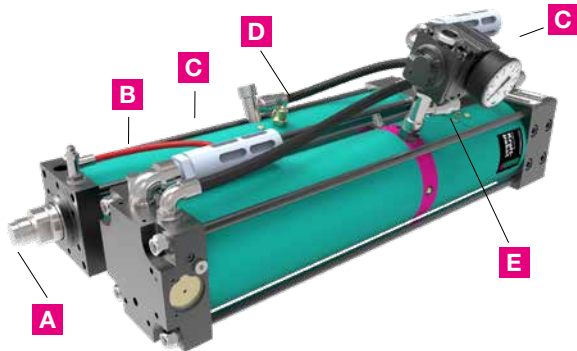

Mounting positions for accessories:

- A** Press force sensor ZPS
- B** Stroke request for forward / return stroke ZHU
- C** Analog position sensor ZHW and ZKW
- D** Electronic pressure switch ZDO
- E** Oil level monitoring ZU

With a large number of useful accessories, you can also expand your TOX® Powerpackage abilities and optimize it for your application.

The **press force sensor ZPS** is screwed onto the working piston and measures press forces in pull and push directions. It is protected against dust and dirt, sturdy, compact and impresses with its high measuring accuracy.



The **electronic pressure switch ZDO** detects the oil pressure in the high-pressure section as system pressure and indicates this as a 4-digit LED display. Two output signals are created according to the switching function set.



All TOX® Powerpackages of the types line-Q and line-X up to size 030 are equipped with a special barrel and a magnetic disk on the working piston. The **stroke request for forward and return stroke ZHU** determines their position via a sensor. This allows you to sense any position relevant to your application.

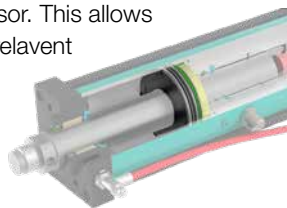

The **coupling ZWK** connects the TOX® Powerpackage (press) and tool flexibly so that the TOX® Powerpackage is not affected by lateral forces. It is screwed directly onto the TOX® Powerpackage piston rod and is available in lengths from 60 to 320 mm.



The distance transducer indicates the absolute actual position of the TOX® Powerpackage piston. The **travel measuring system ZHW/ZKW** can be installed externally (ZKW) as well as internally (ZHW). It operates contact free and is thus wear-free and resistant to contamination and interference fields.



The **oil pump ZP** enables filling up and lowering of the oil volume of the TOX® Powerpackages without the formation of bubbles. It ensures the optimum maintenance procedure and long operating intervals. The transparent container and filler hose facilitate the oil level monitoring.



Possible applications



Presses

The functional design of the TOX® Presses based on the modular principle enables simple and economic adaptation to your individual specifications, from standard presses to individual special machines as a system solution.

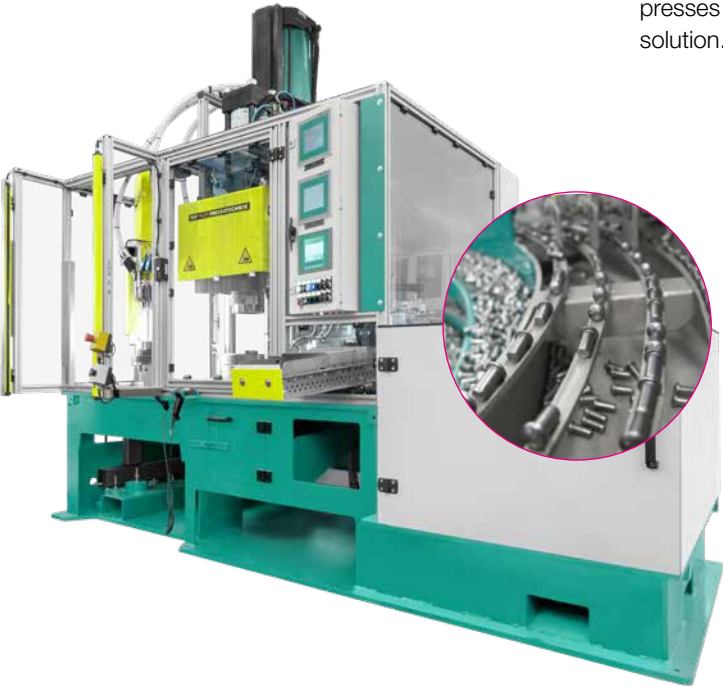

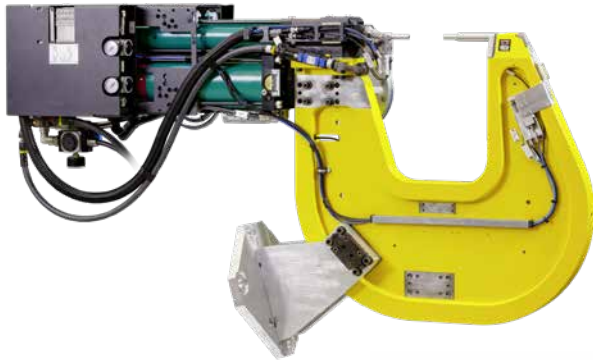

Tongs

The TOX® Robot Tongs and TOX® Machine Tongs are individually configured using our standard C-frame, drive, tool and control components and are supplied completely ready for connection. The TOX® Powerpackages used here are equipped with retract damping as standard. This enables extremely high frequencies while protecting the attached elements from shock.



Special machines

TOX® Powerpackages are also used in many special machines: for pressing in elements, punching, joining of sheet metal with the TOX® Clinch Technology, rivet technology and many more assembly processes. The drives meet all process requirements here. They are powerful, economical, easy to maintain, and simple to implement.

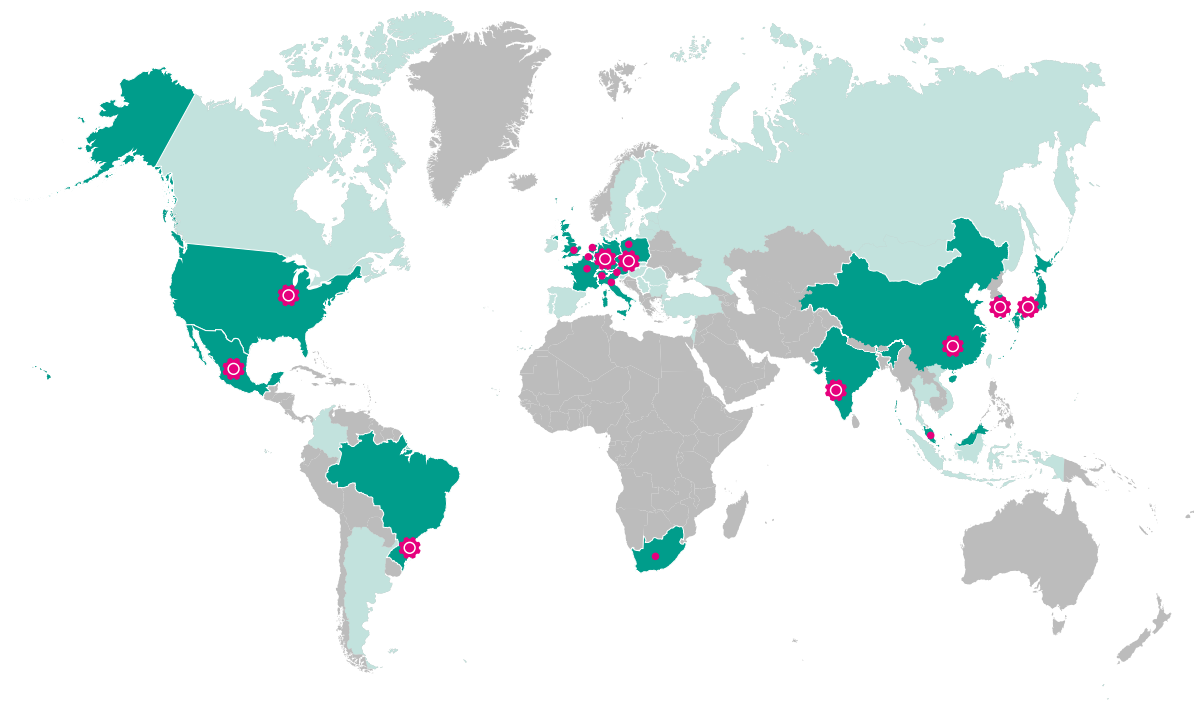

TOX® PRESSOTECHNIK GmbH & Co. KG
Riedstrasse 4
88250 Weingarten / Germany

Find your local contact at:
www.tox.com

313535 / 10.202309.en Subject to technical modifications.